

Photonic interconnection

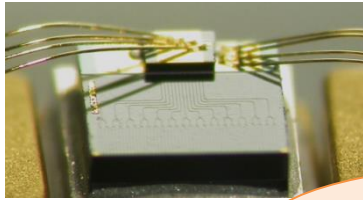

Industrial Technology

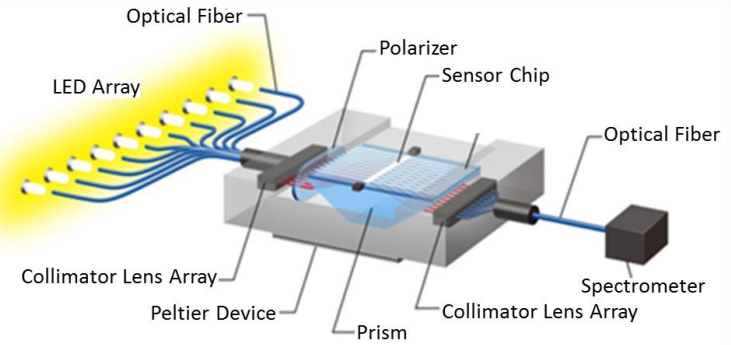

Optical sensing and imaging

Photonics for communication

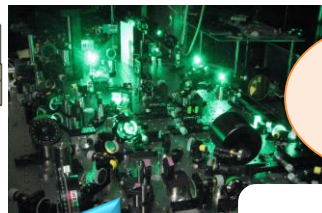

Biological information sensing



New possibility of Electronics and Photonics

Green Innovation

Life Innovation

Oxide / Organic electronics

Basic Technology

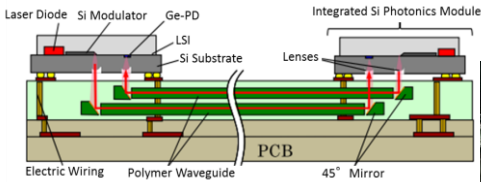

Laser technology

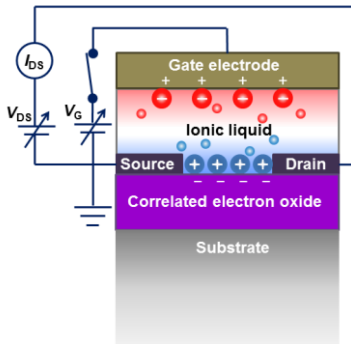

Strongly-correlated electron system Superconductive materials and devices

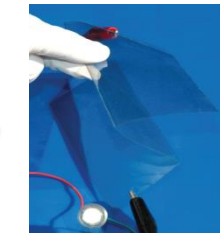
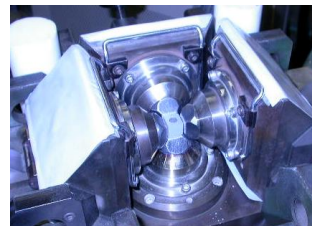

Organic materials and devices

